

OneL

OneL is a seating system designed for semi-public and public spaces, built around a single versatile module. The modules can be configured into various arrangements, offering endless possibilities for shaping public seating areas — including C-shape, S-shape, and L-shape configurations. The module integrates four distinct functions: a bench, an armchair, and a large flower pot that can transform into a table when covered, providing a wide range of uses and adaptability. The L-shaped bench creates a striking visual balance by appearing to rest on a single leg, enhancing legroom and facilitating easy cleaning. This creates an unusually refined and harmonious expression, creating unique, multifunctional typology of furniture.

MODEL

OL3010

DIMENSIONS

Height - 78 cm
Width - 169 cm
Depth - 208 cm

MATERIALS

- 100% recyclable polyethylene
- UV stabilizer
- Anti-microbial

DESIGNER

- Studio Rygalik

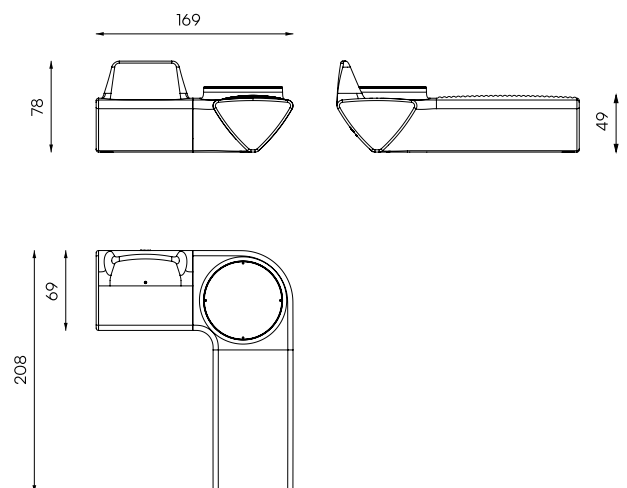

AVAILABLE COLOR VERSIONS



LimeGrayBlack



BlackBrown



BrownBlack



YellowBeige



GrayBeige



BeigeYellow

COLOR RECYCLING PROGRAM

LOOPE redefines design - pioneering 100% circular technology to craft thoughtful, timeless, furniture solutions for a better life and a sustainable future.

Technology and material innovation are at the heart of LOOPE, offering endless possibilities. Plastic is often controversial, but our project proves that it can be used responsibly. We manufacture furniture from pre-consumer recycled polyethylene, ready to be recycled repeatedly under controlled conditions. Sourced from fully valuable material left over from the production of planters, kayaks and other large-format elements made in our factory in Poland. This material returns to circulation in the form of durable furniture, instead of ending up as waste.

With full control over the recycling process, we ensure the polyethylene remains uncontaminated and, under controlled conditions, retains its key properties. This exceptional material is resistant to weather, scratches, breaks, and impacts. It's flexible, soft, yet incredibly durable extending the life of each piece.

ADDITIONAL INFORMATION

MAINTENANCE

- Products can be cleaned with warm water and a mild detergent.
- Avoid using harsh cleaning agents that may damage the surface.

TEMPERATURE RESISTANCE

- High-quality polyethylene retains its properties in temperatures ranging from -30°C to +60°C.

WARRANTY

- LOOPE is more than just furniture - it's a thoughtful system that redefines consumption.
- After five years, customers can return their furniture, and we'll transform it into a new product. This way, we extend its life and reduce plastic production. Warranty covers color and shape deformation.
- The color of the furniture may differ slightly from the visualization, which does not constitute a defect in the product and cannot be the basis for a complaint. LOOPE furniture is made of recycled material, thus the inclusions of other colors are normal and do not affect the functional characteristics.

DIGITAL FILE BASE

- PHOTOS
- VISUALIZATIONS
- 2D & 3D FILES