



faT Table

faT Table is a versatile furniture system offering limitless possibilities for table configurations. Large, substantial pillars, similar to those in the ROUNDER collection, are topped with tabletops available in various shapes and sizes. In addition to the standard color and dimension options, custom finishes can be applied to meet specific design needs. Like the ROUNDER collection, the FaT Table system includes three standard table heights: coffee table, café table, and bar-height table. Larger tabletops can be supported by two or more pillars, ensuring stability and flexibility in design. The name of the collection reflects the contrast between the large, solid pillars and the slim, elegant tabletops crafted from durable black HPL. This balance of strength and refinement defines the cohesive and sophisticated character of the collection.

MODEL

FT5034

DIMENSIONS

Height - 55 cm
Diameter - 110 cm

Available heights - 55, 71, 109 (cm)
Available tabletop diameter - 65, 80, 90, 100, 110, 120 (cm)

MATERIALS

- 100% recyclable polyethylene
- UV stabilizer
- Anti-microbial

DESIGNER

- Studio Rygalik

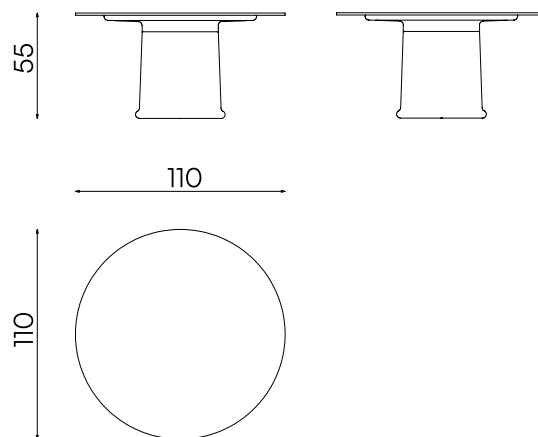

AVAILABLE COLOR VERSIONS



COLOR RECYCLING PROGRAM

LOOPE redefines design - pioneering 100% circular technology to craft thoughtful, timeless, furniture solutions for a better life and a sustainable future.

Technology and material innovation are at the heart of LOOPE, offering endless possibilities. Plastic is often controversial, but our project proves that it can be used responsibly. We manufacture furniture from pre-consumer recycled polyethylene, ready to be recycled repeatedly under controlled conditions. Sourced from fully valuable material left over from the production of planters, kayaks and other large-format elements made in our factory in Poland. This material returns to circulation in the form of durable furniture, instead of ending up as waste.

With full control over the recycling process, we ensure the polyethylene remains uncontaminated and, under controlled conditions, retains its key properties. This exceptional material is resistant to weather, scratches, breaks, and impacts. It's flexible, soft, yet incredibly durable extending the life of each piece.

ADDITIONAL INFORMATION

MAINTENANCE

- Products can be cleaned with warm water and a mild detergent.
- Avoid using harsh cleaning agents that may damage the surface.

TEMPERATURE RESISTANCE

- High-quality polyethylene retains its properties in temperatures ranging from -30°C to +60°C.

WARRANTY

- LOOPE is more than just furniture - it's a thoughtful system that redefines consumption.
- After five years, customers can return their furniture, and we'll transform it into a new product. This way, we extend its life and reduce plastic production. Warranty covers color and shape deformation.
- The color of the furniture may differ slightly from the visualization, which does not constitute a defect in the product and cannot be the basis for a complaint. LOOPE furniture is made of recycled material, thus the inclusions of other colors are normal and do not affect the functional characteristics.

DIGITAL FILE BASE

- PHOTOS
- VISUALIZATIONS
- 2D & 3D FILES